



PRESCOTT

DESCRIPTION: Fire pit **TEXTURE:** Natural stone



NOTES

Sold as a kit not pre-assembled.
Piedimonte caps included.

Techo-Bloc is not responsible for any damages to the firepit if it is not installed with a sleeve or accessory kit. The firepit is not designed for large fires. Fire should be contained at least 6" away from the firepit wall blocks. Overheating could lead to heat damage to the firepit components.

*For an authentic look, each color option is composed of a variety of darker & lighter tones. Natural ingredients such as granite are present within the recipe to allow for a range in tones, veining and textures from one stone to another.

See 119 for more technical information.

Specifications per pallet	Imperial	Metric
Approx. Weight	2 813 lbs	1276 kg
Height	18 in	457 mm
Depth	51 ¾ in	1 314 mm
Length	51 ¾ in	1 314 mm
Piedimonte caps	6	
Prescott 2,25" block	7 A , 18 B , 7 C	
Prescott 4,5" block	3 A , 6 B , 3 C	
Prescott 2,25" corner block	16	
Prescott 4,5" corner block	6	

Insert

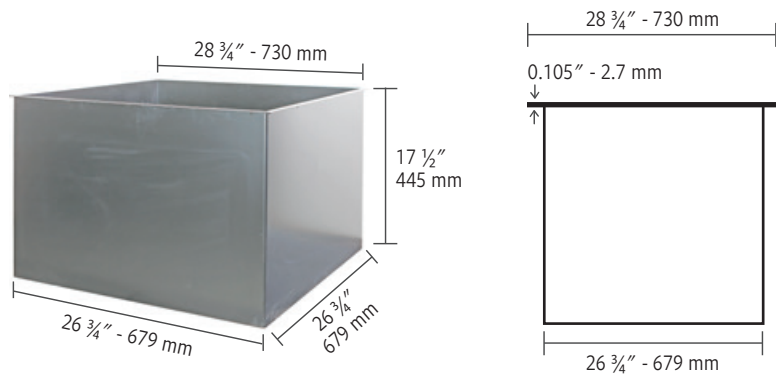

Gas Insert

Gas insert kits available and sold separately (Natural Gas or Liquid Propane).

The kit includes: Brass Burner (240K BTU), Aluminum Plate, Ignition control (push button), collars, vents, aluminum cover and black lava rock.

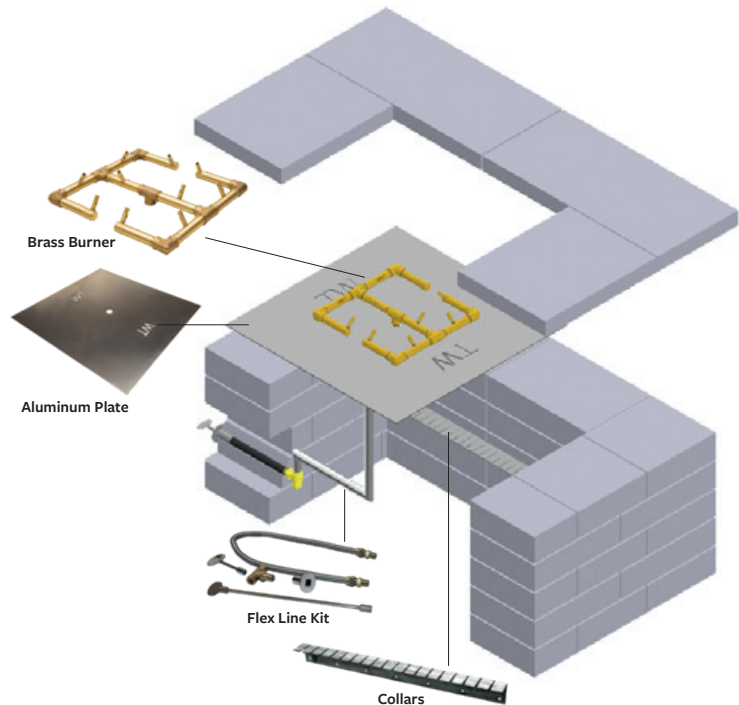

FIRE PIT CAP
Rock Garden Brown



FIRE PIT CAP
Riviera

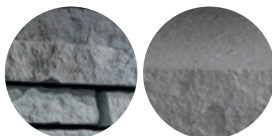

INSTALLATION GUIDE

PRESCOTT FIRE PIT (KIT)

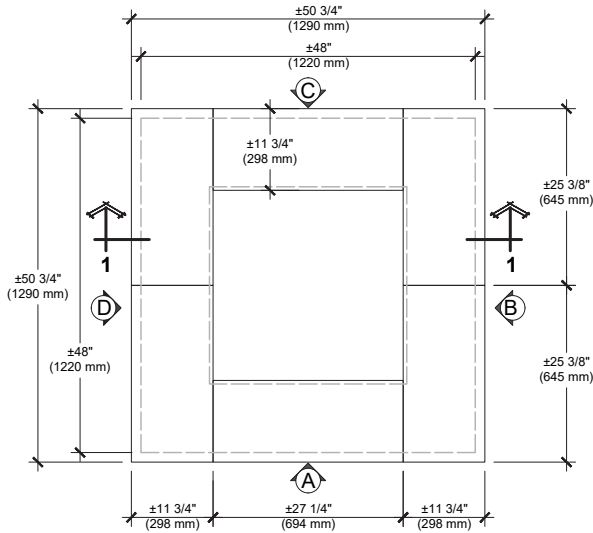

TOP

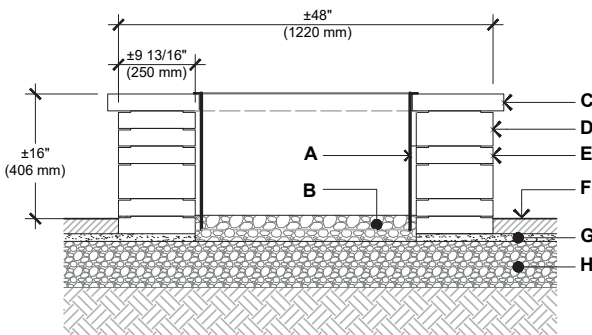

SECTION 1-1

- A. STEEL BOX INSERT
- B. CLEAN STONE 3/4" (20 mm), 4" (100 mm) THICK
- C. PIEDIMONTE CAP (CUT)
- D. PRESCOTT 4.5" BLOCK
- E. PRESCOTT 2.25" BLOCK
- F. TECO-BLOC PAVERS OR SLABS
- G. SETTING BED 1" (25 mm)
- H. COMPACTED GRANULAR BASE 0-3/4" (0-20 mm)
(SEE TABLE PAGE 64 FOR THICKNESS)
- I. PRESCOTT 4.5" CORNER BLOCK
- J. PRESCOTT 2.25" CORNER BLOCK

QUANTITY OF MATERIALS REQUIRED

- Piedimonte cap: **6**
- Prescott 2.25" block: **7 A, 18 B, 7 C**
- Prescott 4.5" block: **3 A, 6 B, 3 C**
- Prescott 2.25" corner block: **16**
- Prescott 4.5" corner block: **6**

NOTE: Secure the blocks using a heat resistant concrete adhesive. The installer must ensure that the installation and use of the firepit comply with local regulations and code requirements.

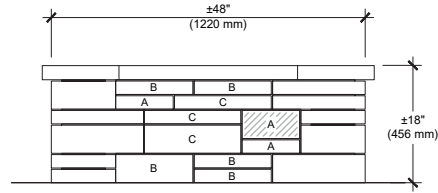

ELEVATION A

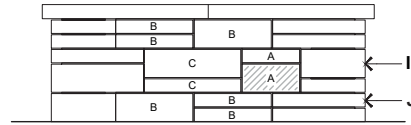

ELEVATION B

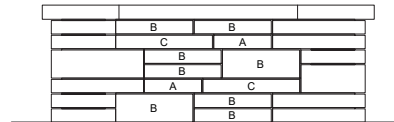

ELEVATION C

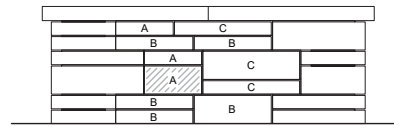

ELEVATION D

Consult our Installation Guide in our website for a detailed step by step installation.