

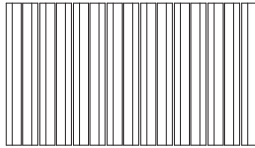

ICONIC FASCIA WALL COLLECTION

DESCRIPTION: Fascia Panel & Corner **TEXTURE:** Klean-Bloc Natural Stone

PALLET OVERVIEW - PANELS



PALLET OVERVIEW - CORNERS

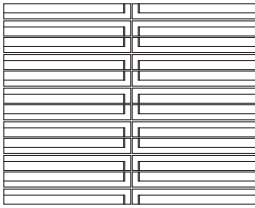

Specifications per pallet		Imperial	Metric
FASCIA	Cubing	45 units	45 units
		47.95 ft ²	4.46 m ²
		97.44 lin. ft	29.70 lin. m
	Approx. Weight	1 390 lbs	630 kg
	Number of rows	3	
	Coverage per row	15.98 ft ²	1.49 m ²
	Linear coverage per row	32.48 lin. ft	9.90 lin. m

Unit dimensions		in	mm	Units/pallet
 A	Height	5 ⁷ / ₈	150	45 units
	Depth	2 ³ / ₄	70	
	Length	26	660	

Specifications per pallet		Imperial	Metric
CORNER	Cubing	24 units	24 units
	Approx. Weight	700 lbs	318 kg
	Number of rows	1	
	Pillar height	35 ⁷ / ₁₆ in	900 mm

Unit dimensions		in	mm	Units/pallet
 A LEFT UNIT	Height	5 ⁷ / ₈	150	12 units
	Depth	2 ³ / ₄	70	
	Length	23 ¹ / ₄	590	

Unit dimensions		in	mm	Units/pallet
 B RIGHT UNIT	Height	5 ⁷ / ₈	150	12 units
	Depth	2 ³ / ₄	70	
	Length	23 ¹ / ₄	590	



COMPATIBLE CAPS

See page 140 for product compatibility.

Klean-Bloc technology
See page 24.

NOTES

See page 135 to 156 for more technical information.

Fascia Panels require single-sided structural blocks (retaining wall application) or double-sided structural blocks (freestanding walls). Sold Separately.

Rock Garden Brown

Victoria

Riviera

Onyx Black



INSTALLATION GUIDE

FREESTANDING WALL

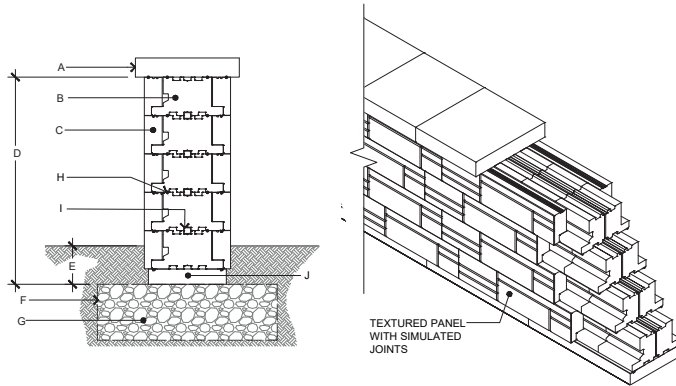

- A. TECHO-BLOC CAP UNIT SECURED TO CORE AND PANEL BELOW WITH FLEXLOCK ADHESIVE
- B. STRUCTURAL BLOCK DOUBLE-SIDED UNIT
- C. PANEL UNIT
- D. 29 1/2" (750 mm) MAX.
- E. EMBEDMENT DEPTH 6" (150 mm) MIN.
- F. GEOTEXTILE
- G. COMPACTED GRANULAR BASE 6" (150 mm) MIN. THICKNESS ACCORDING TO PROJECT SPECIFICATIONS
- H. FLEXLOCK ADHESIVE
- I. HDPE HORIZONTAL KEY
- J. BASE UNIT

FREESTANDING WALL - 90° CORNER

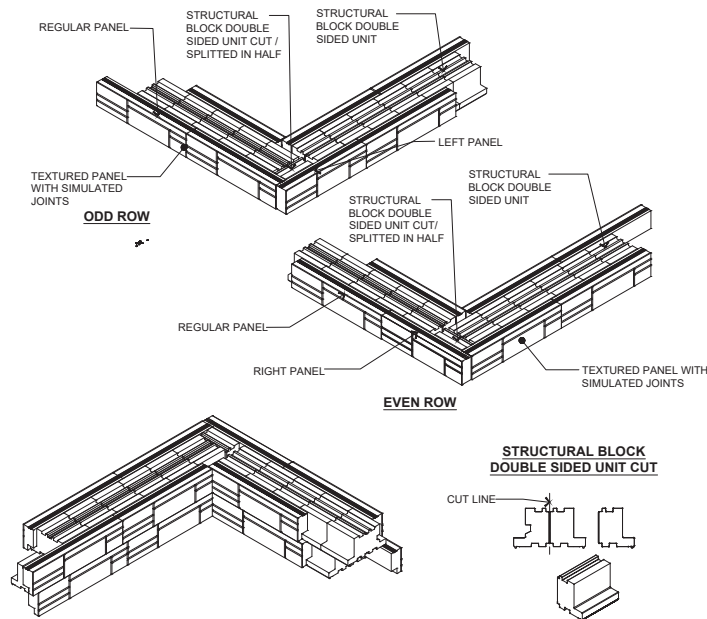

1. ALTERNATE ODD AND EVEN ROWS.
2. STAGGER STRUCTURAL BLOCKS JOINTS FROM ONE ROW TO THE NEXT.
3. GLUE ALL STRUCTURAL BLOCKS AT EACH ROW WITH FLEXLOCK ADHESIVE.
4. APPLY FLEXLOCK ADHESIVE ON TOP OF UPPERMOST PANEL UNITS TO FIX CAP UNITS.
5. STRUCTURAL BLOCK DOUBLE SIDED UNIT CUT / SPLITTED IN HALF MUST ALWAYS BE PRESENT AT THE CORNER OF THE WALL.

GRAVITY RETAINING WALL

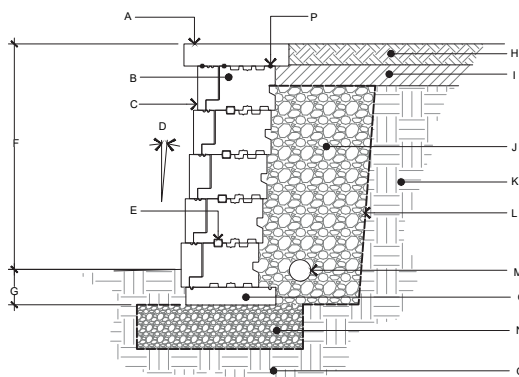

- A. TECHO-BLOC CAP UNIT SECURED TO UNIT BELOW WITH FLEXLOCK ADHESIVE
- B. STRUCTURAL BLOCK SINGLE SIDED UNIT
- C. PANEL UNIT
- D. WALL INCLINATION (5.3°)
- E. HDPE HORIZONTAL KEY
- F. EXPOSED HEIGHT
- G. EMBEDMENT DEPTH
- H. TOP SOIL
- I. LOW PERMEABILITY SOIL
- J. 3/4" (20 mm) CLEAN STONE 14" (350mm) THICK MIN.
- K. RETAINED SOIL
- L. GEOTEXTILE
- M. PERFORATED DRAIN
- N. LEVELING PAD
- O. FOUNDATION SOIL
- P. FLEXLOCK ADHESIVE
- Q. BASE UNIT

INSTALLATION GUIDE

FREESTANDING END OF A STRAIGHT WALL (OPTION 1)

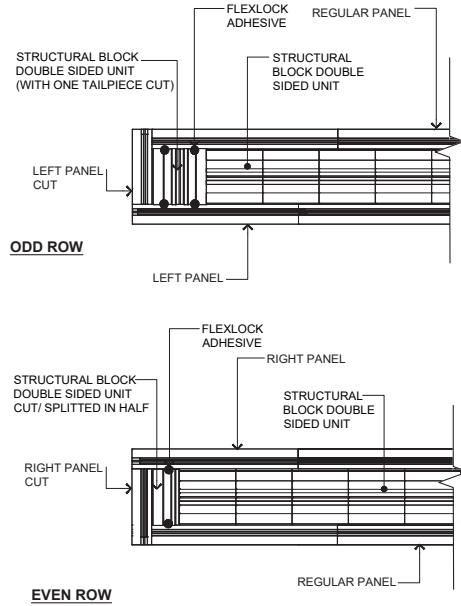

NOTES:

1. ALTERNATE ODD AND EVEN ROWS.
2. STAGGER STRUCTURAL BLOCKS JOINTS FROM ONE ROW TO THE NEXT.
3. GLUE ALL STRUCTURAL BLOCKS AT EACH ROW WITH FLEXLOCK ADHESIVE.
4. APPLY FLEXLOCK ADHESIVE ON TOP OF UPPERMOST PANEL UNITS TO FIX CAP UNITS.

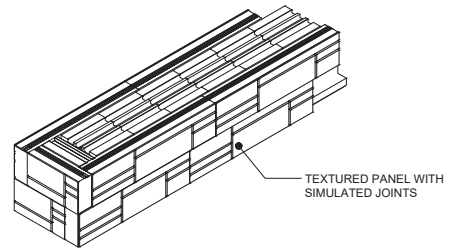

FREESTANDING END OF A STRAIGHT WALL (OPTION 2)

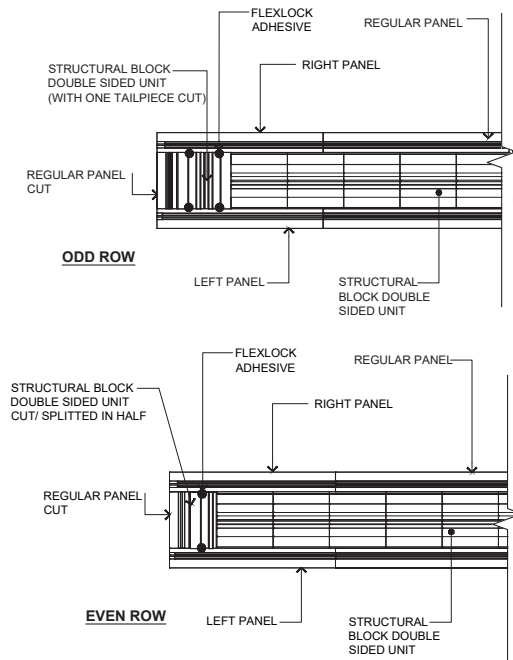

NOTES:

1. ALTERNATE ODD AND EVEN ROWS.
2. STAGGER STRUCTURAL BLOCKS JOINTS FROM ONE ROW TO THE NEXT.
3. GLUE ALL STRUCTURAL BLOCKS AT EACH ROW WITH FLEXLOCK ADHESIVE.
4. APPLY FLEXLOCK ADHESIVE ON TOP OF UPPERMOST PANEL UNITS TO FIX CAP UNITS.

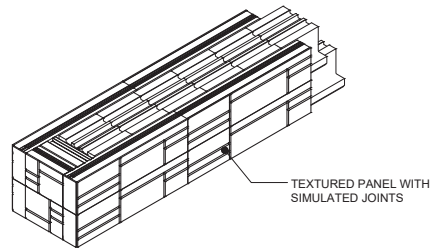

INSTALLATION GUIDE

PILLARS - FASCIA WALL COLLECTION

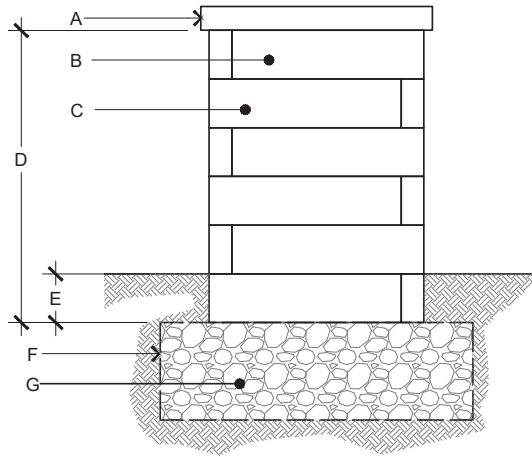

STRUCTURAL BLOCK SINGLE SIDED UNIT CUT / SPLITTED IN HALF

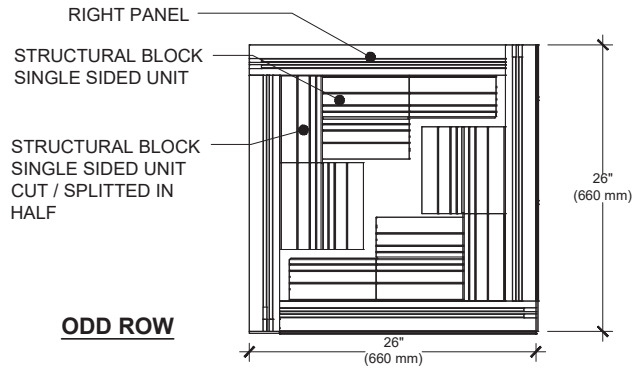
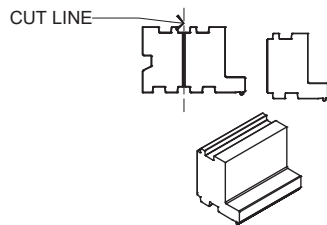

ODD ROW

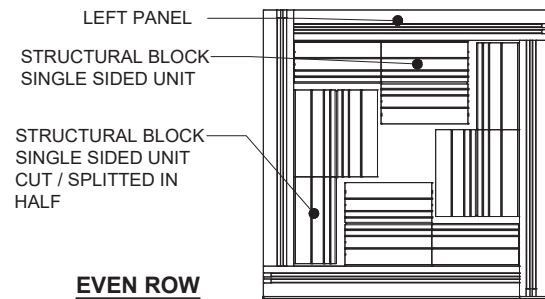

EVEN ROW

NOTE: SECURE EACH ROW WITH FLEXLOCK ADHESIVE.

- A. PILLAR CAP UNIT SECURED TO CORE AND PANEL BELOW WITH FLEXLOCK ADHESIVE
- B. RIGHT PANEL
- C. LEFT PANEL
- D. 35 7/16" (900 mm) MAX HEIGHT
- E. EMBEDMENT DEPTH 6" (150 mm) MIN.
- F. GEOTEXTILE
- G. COMPACTED GRANULAR BASE 6" (150 mm) MIN. THICKNESS ACCORDING TO PROJECT SPECIFICATIONS.

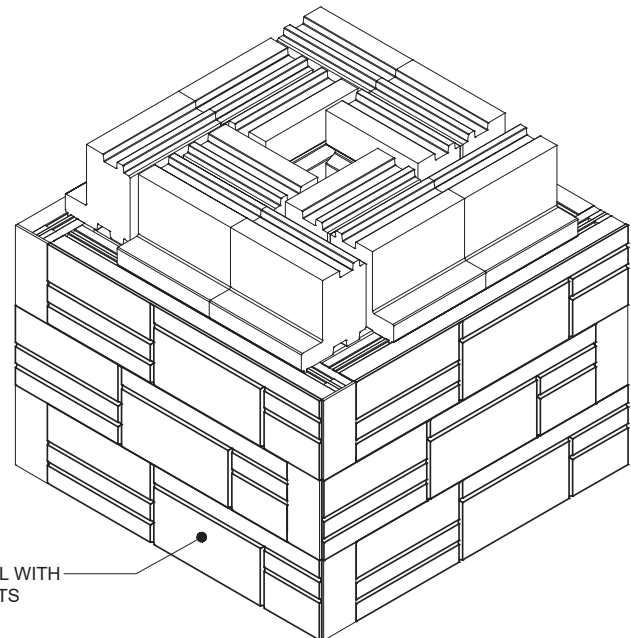

TEXTURED PANEL WITH SIMULATED JOINTS

For all possible combinations of pillars and caps, please refer to the correspondence table on page 140

PLEASE REFER TO P.4 FOR THE CORRECT USE AND LIMITATIONS OF PROVIDED TECHNICAL INFORMATION.

INSTALLATION GUIDE

STEPS - FASCIA WALL COLLECTION

