

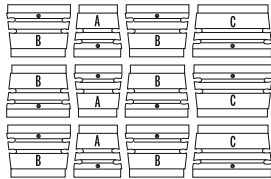

PRESCOTT 2.25"

DESCRIPTION: Wall double-sided **TEXTURE:** Natural stone

PALLET OVERVIEW



COMPATIBLE CAPS

See page 140 for product compatibility.

NOTES





When building a double-sided wall one pallet will cover an average of 25.23 ft².

*For an authentic look, each color option is composed of a variety of darker & lighter tones. Natural ingredients such as granite are present within the recipe to allow for a range in tones, veining and textures from one stone to another.

The dimensional tolerance for Stonedge wet cast retaining wall units is: $\pm \frac{3}{16}$ " (5 mm) for height and $\pm \frac{1}{2}$ " (13 mm) for length and width. During the installation, the level between adjacent wall units will vary (usually more than for a dry cast wall unit) in order to obtain a more realistic appearance of a natural stone wall.

See page 135 to 156 for more technical information.

Specifications per pallet	Imperial	Metric
Cubing	27 ft²	2.51 m ²
	144 lin. ft	43.89 lin. m
Approx. Weight	2 661 lbs	1 207 kg
Minimum radius	5.2 ft	1.6 m
Number of rows	12	
Coverage per row	2.25 ft ²	0.21 m ²
Linear coverage per row	12 lin. ft	3.66 lin. m

	Unit dimensions	in	mm	Units/pallet
 	Height	2 $\frac{1}{4}$	57	36 units
	Depth	9 $\frac{13}{16}$	250	
	Length 1	9	229	
	Length 2	7 $\frac{7}{16}$	189	
	Height	2 $\frac{1}{4}$	57	72 units
	Depth	9 $\frac{13}{16}$	250	
	Length 1	12	305	
	Length 2	10 $\frac{7}{16}$	265	
	Height	2 $\frac{1}{4}$	57	36 units
	Depth	9 $\frac{13}{16}$	250	
	Length 1	15	381	
	Length 2	13 $\frac{7}{16}$	341	

Rock Garden Brown

Victoria

Riviera





PRESCOTT 4.5"

DESCRIPTION: Wall double-sided **TEXTURE:** Natural stone

PALLET OVERVIEW

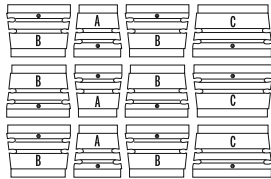

COMPATIBLE CAPS

See page 140 for product compatibility.

NOTES

When building a double-sided wall one pallet will cover an average of 25.23 ft².

*For an authentic look, each color option is composed of a variety of darker & lighter tones. Natural ingredients such as granite are present within the recipe to allow for a range in tones, veining and textures from one stone to another.

The dimensional tolerance for Stonedge wet cast retaining wall units is: $\pm \frac{3}{16}$ " (5 mm) for height and $\pm \frac{1}{2}$ " (13 mm) for length and width. During the installation, the level between adjacent wall units will vary (usually more than for a dry cast wall unit) in order to obtain a more realistic appearance of a natural stone wall.

See page 135 to 156 for more technical information.

Specifications per pallet	Imperial	Metric
Cubing	27 ft²	2.51 m ²
	72 lin. ft	21.95 lin. m
Approx. Weight	2 728 lbs	1 237 kg
Minimum radius	5.2 ft	1.6 m
Number of rows	6	
Coverage per row	4.50 ft ²	0.42 m ²
Linear coverage per row	12 lin. ft	3.66 lin. m

	Unit dimensions	in	mm	Units/pallet
	Height	4 ½	114	18 units
	Depth	9 13/16	250	
	Length 1	9	229	
	Length 2	7 7/16	189	
	Height	4 ½	114	36 units
	Depth	9 13/16	250	
	Length 1	12	305	
	Length 2	10 7/16	265	
	Height	4 ½	114	18 units
	Depth	9 13/16	250	
	Length 1	15	381	
	Length 2	13 7/16	341	

Rock Garden Brown

Victoria

Riviera





PRESCOTT

DESCRIPTION: Corners and pillars **TEXTURE:** Natural stone

PALLET OVERVIEW



COMPATIBLE CAPS

See page 140 for product compatibility.

NOTES

*For an authentic look, each color option is composed of a variety of darker & lighter tones. Natural ingredients such as granite are present within the recipe to allow for a range in tones, veining and textures from one stone to another.

The dimensional tolerance for Stonedge wet cast retaining wall units is: $\pm \frac{3}{16}$ " (5 mm) for height and $\pm \frac{1}{2}$ " (13 mm) for length and width. During the installation, the level between adjacent wall units will vary (usually more than for a dry cast wall unit) in order to obtain a more realistic appearance of a natural stone wall.

See page 135 to 156 for more technical information.

Specifications per pallet		Imperial	Metric
2.25"	Cubing	72 units	72 units
	Approx. Weight	1 789 lbs	811 kg
	Number of rows	8	
	Pillar height	40 ½ in	1 029 mm



A



Unit dimensions	in	mm	Units/pallet
Height	2 ¼	57	72 units
Depth	9 13/16	250	
Length	14 3/16	360	

Specifications per pallet		Imperial	Metric
4.5"	Cubing	36 units	36 units
	Approx. Weight	1 871 lbs	849 kg
	Number of rows	4	
	Pillar height	40 ½"	1 029 mm



A



Unit dimensions	in	mm	Units/pallet
Height	4 ½	114	36 units
Depth	9 13/16	250	
Length	14 3/16	360	

Rock Garden Brown

Victoria

Riviera

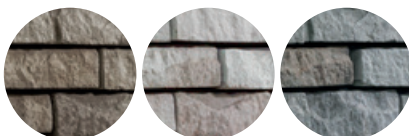

PRESCOTT RETAINING WALL – LAYING PATTERNS

The different modules of the Prescott retaining wall allow the installation of different block combinations. Eight combinations are shown as an example. Each combination is 24" (610 mm) long and 6 3/4" (171 mm) high.

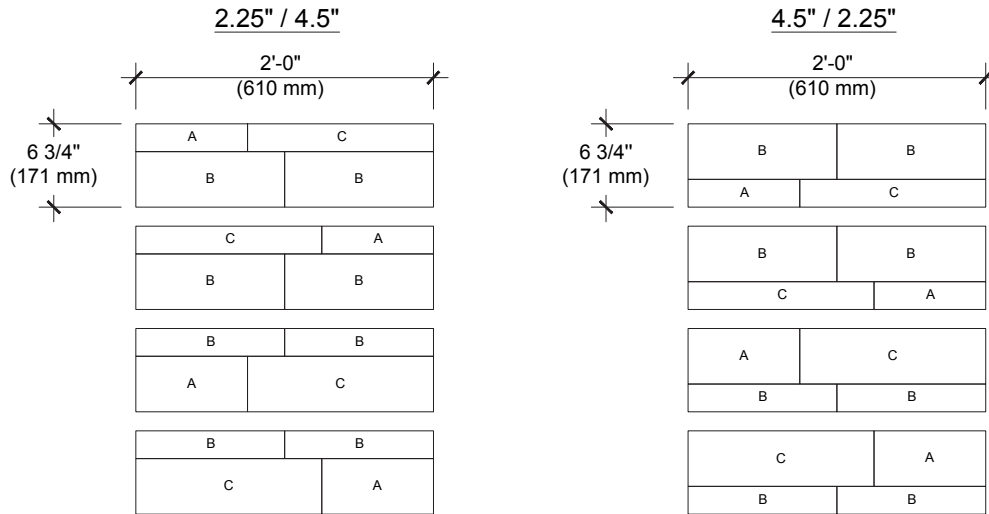

The wall installation will be facilitated if the height of the wall is calculated in multiples of 6 3/4" and the length in multiples of 24".

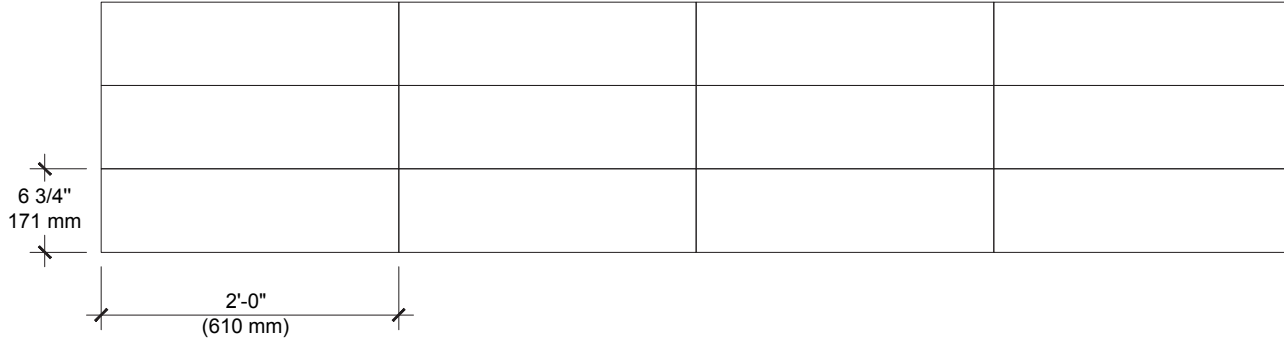

Percentage of blocks required
 Prescott 2.25": 33 % of the surface
 Prescott 4.5": 67 % of the surface

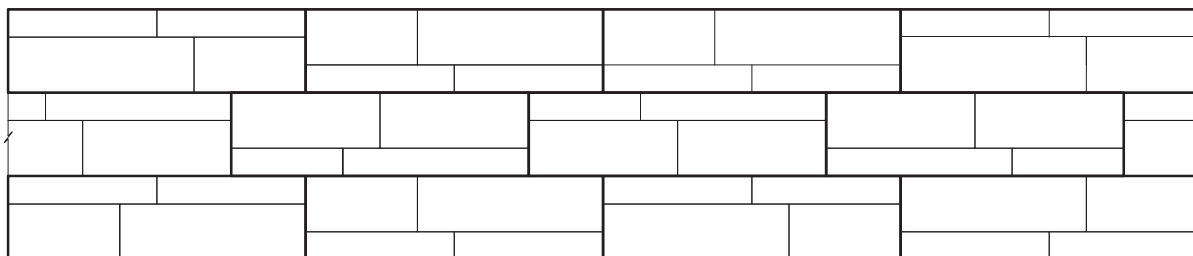

INSTALLATION GUIDE

FREESTANDING WALLS - PRESCOTT 2.25" & 4.5"

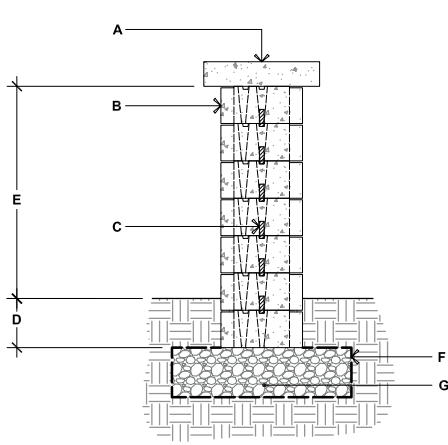

PRESCOTT 2.25" & 4.5"

- A.** TECO-BLOC CAP UNIT, SECURED TO UNIT BELOW WITH FLEXLOCK ADHESIVE
- B.** PRESCOTT 2.25" AND 4.5" DOUBLE-SIDED WALL UNITS SECURE EACH ROW WITH FLEXLOCK ADHESIVE
- C.** CONNECTOR
- D.** EMBEDMENT DEPTH, 6" (150 mm) MIN.
- E.** 25 1/2" (650 mm) MAX.
- F.** GEOTEXTILE
- G.** COMPACTED GRANULAR LEVELING PAD, 6" (150 mm) THICK MIN. THICKNESS ACCORDING TO PROJECT SPECIFIC CONDITIONS

90° CORNER OF A DOUBLE-SIDED WALL

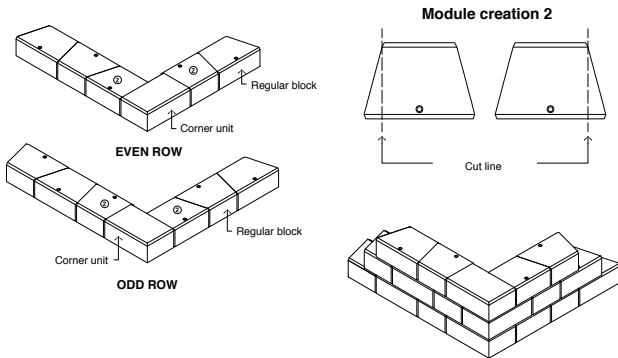

DOUBLE-SIDED WALL - END OF A STRAIGHT WALL

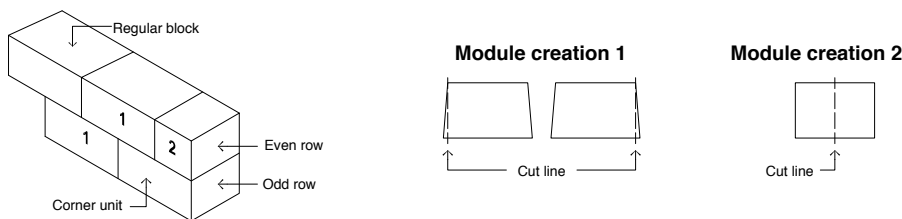

GENERAL NOTES

1. Alternate odd and even rows.
2. Stagger joints from one row to the next.
3. Glue all modules at each row with Flexlock adhesive.
4. Cavities, grooves and connectors are not illustrated to avoid overloading the image.

PLEASE REFER TO P.4 FOR THE CORRECT USE AND LIMITATIONS OF PROVIDED TECHNICAL INFORMATION.

INSTALLATION GUIDE

DOUBLE-SIDED WALL RADIUS - PRESCOTT 2.25" & 4.5"

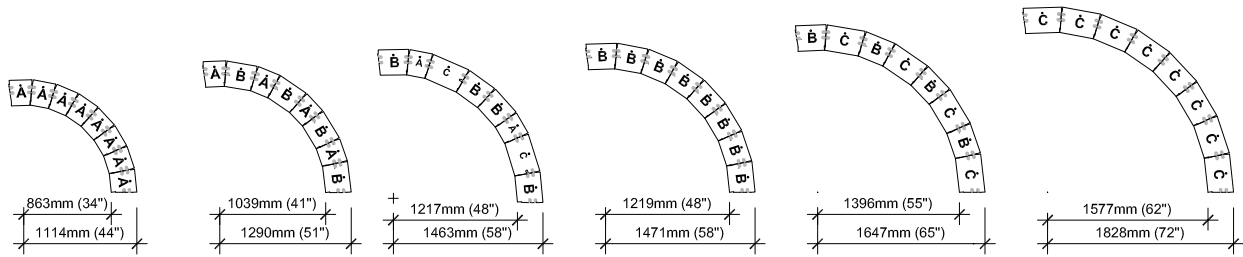

It is the user's responsibility to verify for the quantity of materials required.

STEPS

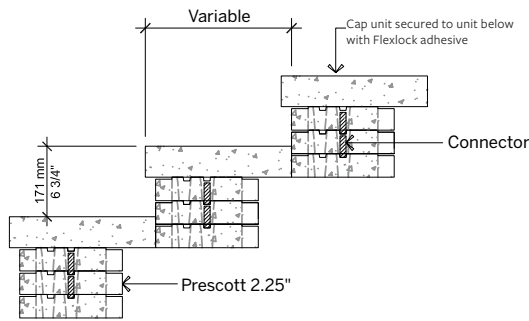

For all possible combinations of pillars and caps, please refer to the correspondence table on page 140

INSTALLATION GUIDE

PILLARS - PRESCOTT 2.25" & 4.5"

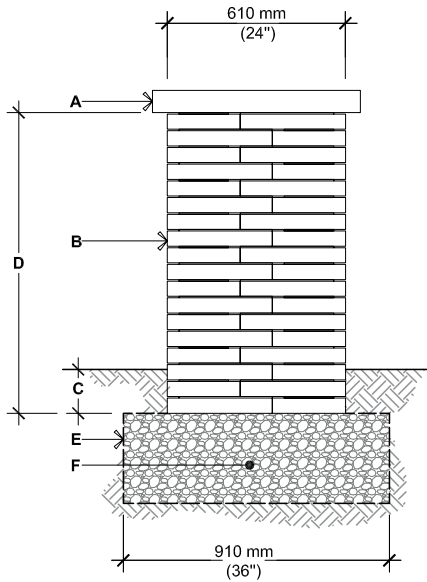

○ PRESCOTT 2.25"

- A.** PILLAR CAP UNIT
(SECURE WITH FLEXLOCK ADHESIVE)
- B.** PRESCOTT 2.25" PILLAR UNIT SECURE EACH ROW
WITH FLEXLOCK ADHESIVE
- C.** EMBEDMENT DEPTH, 6" (150 mm) MIN.
- D.** 40 1/2" (1 029 mm), HEIGHT PER PALLET
45" (1 143 mm), MAX. HEIGHT
- E.** GEOTEXTILE
- F.** COMPACTED GRANULAR BASE 6" (150 mm)
THICK MIN. THICKNESS ACCORDING TO PROJECT
SPECIFIC CONDITIONS

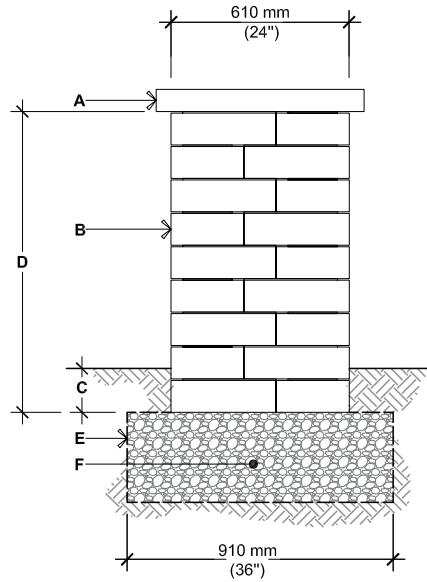

○ PRESCOTT 4.5"

- A.** PILLAR CAP UNIT
(SECURE WITH FLEXLOCK ADHESIVE)
- B.** PRESCOTT 4.5" PILLAR UNIT SECURE EACH ROW
WITH FLEXLOCK ADHESIVE
- C.** EMBEDMENT DEPTH, 6" (150 mm) MIN.
- D.** 40 1/2" (1 029 mm), HEIGHT PER PALLET
45" (1 143 mm), MAX. HEIGHT
- E.** GEOTEXTILE
- F.** COMPACTED GRANULAR BASE
6" (150 mm) THICK MIN. THICKNESS
ACCORDING TO PROJECT SPECIFIC CONDITIONS

For all possible combinations of pillars and caps, please refer to the correspondence table on page 140

INSTALLATION GUIDE

PILLARS - PRESCOTT 2.25" & 4.5"

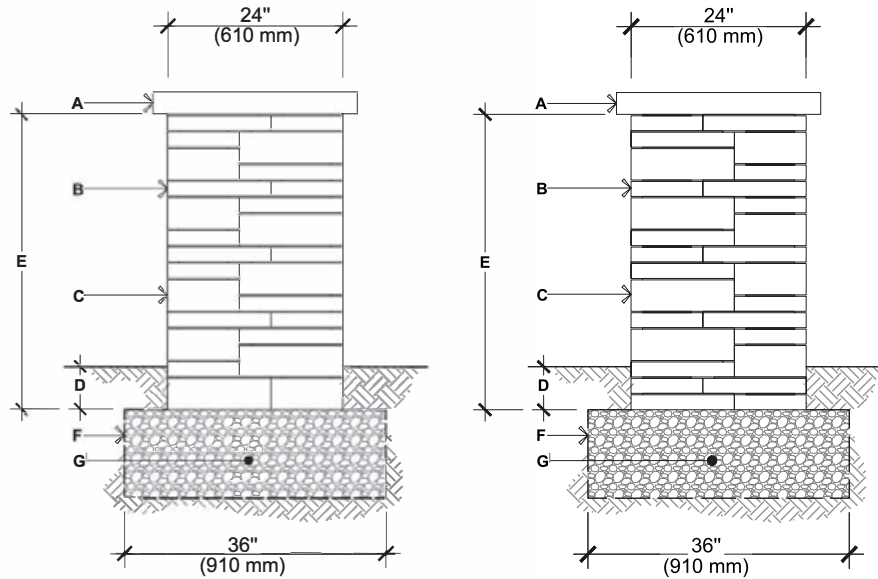

PRESCOTT 2.25" & 4.5" OPTION A

- A.** PILLAR CAP UNIT
(SECURE WITH FLEXLOCK ADHESIVE)
- B.** PRESCOTT 2.25" PILLAR UNIT SECURE EACH ROW
WITH FLEXLOCK ADHESIVE
- C.** PRESCOTT 4.5" PILLAR UNIT SECURE EACH ROW
WITH FLEXLOCK ADHESIVE
- D.** EMBEDMENT DEPTH, 6" (150 mm) MIN.
- E.** 40 ½" (1 029 mm)
45" (1 143 mm), MAX. HEIGHT
- F.** GEOTEXTILE
- G.** COMPACTED GRANULAR BASE 6" (150 mm)
THICK MIN. THICKNESS ACCORDING TO PROJECT
SPECIFIC CONDITIONS

PRESCOTT 2.25" & 4.5" OPTION B

- A.** PILLAR CAP UNIT
(SECURE WITH FLEXLOCK ADHESIVE)
- B.** PRESCOTT 2.25" PILLAR UNIT SECURE EACH ROW
WITH FLEXLOCK ADHESIVE
- C.** PRESCOTT 4.5" PILLAR UNIT SECURE EACH ROW
WITH FLEXLOCK ADHESIVE
- D.** EMBEDMENT DEPTH, 6" (150 mm) MIN.
- E.** 40 ½" (1 029 mm)
45" (1 143 mm), MAX. HEIGHT
- F.** GEOTEXTILE
- G.** COMPACTED GRANULAR BASE 6" (150 mm)
THICK MIN. THICKNESS ACCORDING TO PROJECT
SPECIFIC CONDITIONS

NOTE: Two pillars of 40 ½" total height (one option A and one option B) required one pallet of Prescott 4.5" Pillar unit and one pallet of Prescott 2.25" Pillar unit.

For all possible combinations of pillars and caps, please refer to the correspondence table on page 140

PLEASE REFER TO P.4 FOR THE CORRECT USE AND LIMITATIONS OF PROVIDED TECHNICAL INFORMATION.